

TA3-150-750 SANITARY TURBINE

1-1/2" END CONNECTIONS (BOTH ENDS)

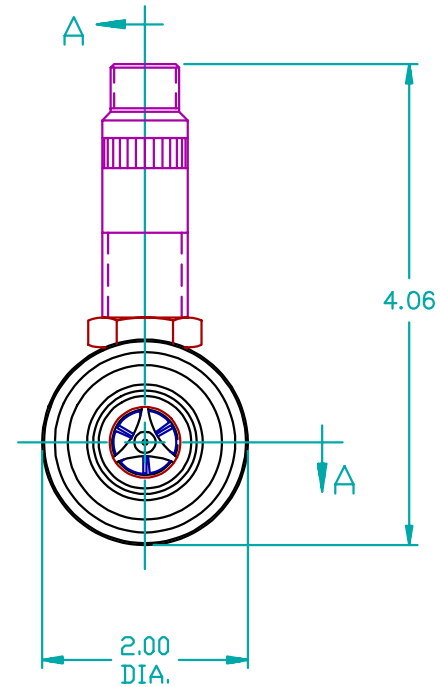
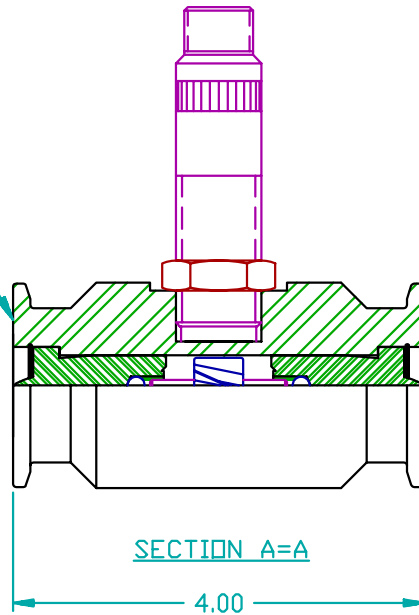

GENERAL SPECIFICATIONS:

SANITARY RATING = 3A COMPLIANT

CLAMP SIZE = 1-1/2"

FLOW RATE = 2 - 15 GPM

PRESSURE RATING: 1000 psi

BEARING MATERIAL: NICKEL BINDERY
TUNGSTEN CARBIDE

WEIGHT = 4 LBS.

PURCHASED PART DRAWING

THIS PRINT, INCLUDING THE INFORMATION CONTAINED IN IT, IS THE PROPERTY OF AW COMPANY. IT IS CONSIDERED PROPRIETARY IN NATURE AND MAY NOT BE USED OR DISCLOSED OUTSIDE OF AW COMPANY, EXCEPT UNDER PRIOR WRITTEN AGREEMENT. ANY MODIFICATIONS MADE TO OR COMMENTS WRITTEN ON THIS DRAWING BY UNAUTHORIZED PERSONNEL WILL VOID THIS DRAWING. ALL DIMENSIONS SHOWN ARE SUBJECT TO CHANGE WITHOUT NOTICE.



AW COMPANY
8809 INDUSTRIAL DRIVE
FRANKSVILLE, WI 53126
TEL. # (262) 884-9800
FAX. # (262) 884-9810

TITLE: TA3-150-750 SANITARY TURBINE	
DRAWING NUMBER: TA31702A	PART NUMBER: TA3-150-750
DATE: 03-23-01	REV: A DRAWN BY: SHANE WILSON
CHECKED BY: S.W.	PAGE 1 OF 1 SCALE: NONE